



雷邦科技照亮你的前程

Reborn Technology Illuminates Your Future



宁波雷邦机械科技有限公司

地址：浙江省宁波市鄞州区时代路 51 号

电话：18868608857

邮箱：zhangzhenyue@reborn-lihting.com

NINGBO REBORN MACHINERY
TECHNOLOGY CO., LTD

宁波雷邦机械科技有限公司

COMPANY PROFILE

公司简介



CERTIFICATION

IATF16949 认证



宁波雷邦机械科技有限公司成立于 2010 年，公司坐落在港口、机场、高速交通均便利的宁波鄞州区五乡镇时代路 51 号。

公司拥有独立的模具设计团队，精密的光学零件模具开发制造技术、完善的光学零件生产制造设备。配备有精密的检测设备监控及专业的质量管控人员，产品通过了 ISO9001，IATF16949 认证

我们将以成为国内外光学零件制造领域的领跑者为目标，将光学零件技术开发作为公司发展核心，为客户提供高效优质的系统解决方案。公司旨在构建完善的软件和硬件设施，并根据发展增加模具加工设备、注塑设备、检测设备等方面，引进优秀人才，以实现公司的创新和发展。

Ningbo REBORN Machinery Technology Co.,Ltd, established in 2010, and it is located in No.51.Shidai Road, Yinzhou Distrct, Ningbo, Zhejiang, China, with convenient transportation. (nearing airport, port and expressway).

Reborn has an independent mold design team, mold design & manufacturing technology of precision optical parts, professional optical parts manufacturing & testing equipments. Also there is a technical team with rich experiences and professional knowledge in this area. Products of Reborn passed ISO9001 & IATF16949.

Aim to be the leader in optical parts manufacturing area. Take technology development of optical parts as our core and provide customers with efficient and high-quality system solutions. With company development Reborn targets to build perfect software & hardware and to equip with mold making equipments & Inspection facilities and etc. Also to achieve development and innovation, Reborn will introduce talents.

OUR EQUIPMENT

我们的设备

制造能力 - 注塑设备

注塑车间配备了自动化供料系统, 60 台注塑机, 其中 6 台双色, 2 台三色, 3 台 LSR 注塑机, 立式机 2 台。

The injection molding workshop is equipped with an automatic feeding system, 60 injection molding machines, including 6 two-color, 2 three-color, 3 LSR injection molding machines, and 2 vertical machines.



INJECTION EQUIPMENT	BRAND	TONNAGE	QUANTITY	REMARK
Injection Molding Machine	TOYO	850T	1	
Injection Molding Machine	BST	650T	1	3K
Injection Molding Machine	MANATEC	650T	1	3K
Injection Molding Machine	SODICK/LK	560T	6	SODICK*1
Injection Molding Machine	SODICK/LK	450T	3	SODICK*2
Injection Molding Machine	LK	450T	1	2K
Injection Molding Machine	ENGEL	400T	1	
Injection Molding Machine	ARBURG	320T	1	2K
Injection Molding Machine	LK	320T	2	
Injection Molding Machine	ZERES	300T	1	
Injection Molding Machine	BST	280T	5	
Injection Molding Machine	BOLE	450T	2	2K

INJECTION EQUIPMENT	BRAND	TONNAGE	QUANTITY	REMARK
Injection Molding Machine	ENGEL	220T	4	
Injection Molding Machine	ENGEL	140T	2	2K
Injection Molding Machine	BST	220T	2	
Injection Molding Machine	ENGEL	150	2	2K
Injection Molding Machine	BK	120	2	立式机
Injection Molding Machine	LK	160T	6	
Injection Molding Machine	SODICK	150T	14	
Injection Molding Machine	FANUC	50T	2	
Silicone injection molding machine	SODICK	100T	1	LSR
Silicone injection molding machine	ARBURG	100T	1	LSR
Silicone injection molding machine	ENGEL	80T	1	LSR

OUR EQUIPMENT

模具加工设备

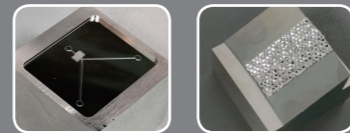

亚士达 950, YASDA640

产地: 日本

转速: 24000, 精度: 0.005mm



EXERON 五轴

产地: 德国

转速: 42000, 精度: 0.005mm

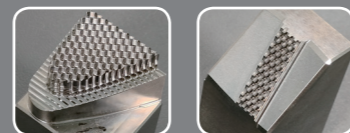

EXERON 五轴

产地: 德国

转速: 42000, 精度: 0.005mm

OUR EQUIPMENT

超精密加工设备

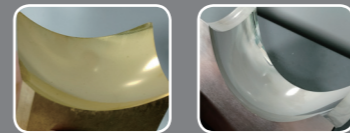

TOSHIBA UVM450

产地: 日本

转速: 60000, 精度: 0.00001mm



Precitech 350

产地: 美国

精度: 0.000001mm

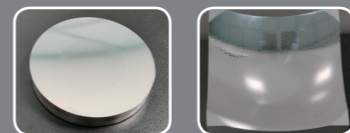

Precitech 650 五轴

产地: 美国

配制: 快刀伺服 / 超声震动 / 铣削 / 刮削

磨削 / 慢刀伺服等功能

精度: 0.000001mm



OUR EQUIPMENT

超精密检测设备



三丰轮廓仪 5000cnc
产地：日本
转精度：0.00625um



泰勒霍普森轮廓仪 PGI
产地：英国
精度：0.064um

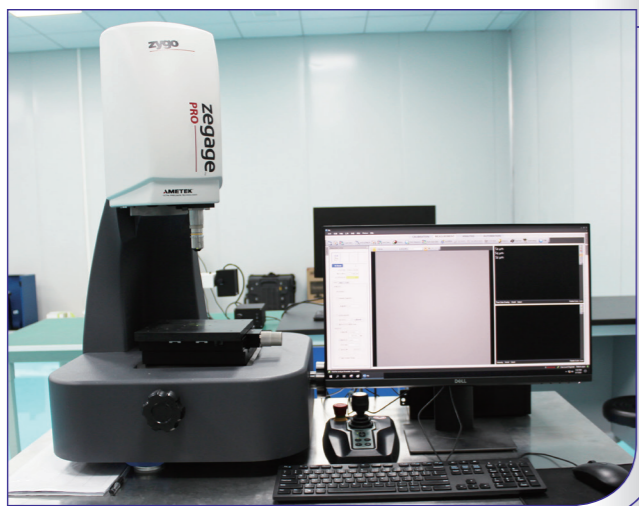

Zygo 白光干涉仪
产地：美国
精度：2nm

OUR EQUIPMENT

光学检测设备

CMM test

ATOS GOM 3D-SCAN

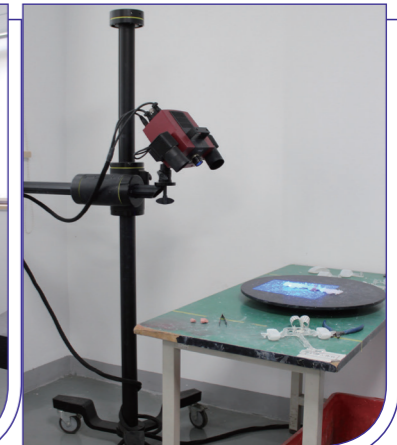

KMP optical test

SPEC GAGE 3D

产地：德国
转精度：10um

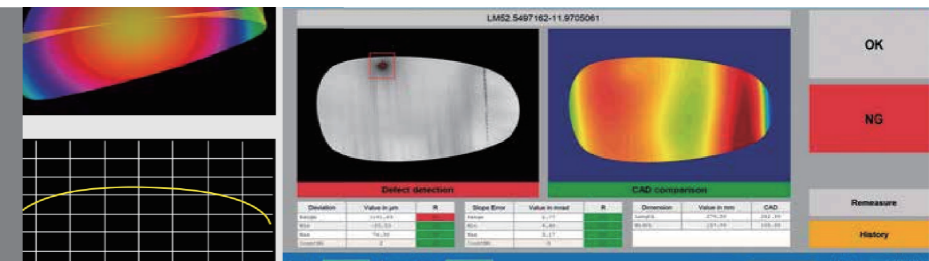

OUR SOFTWARE

设计分析加工软件



CAD



CAE



CAM

REBORN CUSTOMER

我们的客户

我们将延续以质量体系为标准，客户满意的宗旨；提供优良服务和高品质的产品，赢得客户的信赖。公司奉行质量第一，信誉至上，诚挚合作。

We will continue to take the quality system as the standard, customer satisfaction purpose; Provide excellent service and high quality products to win the trust of customers. The company pursues quality first, reputation first, sincere cooperation.



奔驰



宝马



奥迪



大众



丰田



本田



日产



现代



雪佛兰



凯迪拉克



马自达



别克



标致



斯柯达



福特



雪铁龙



三菱



雷克萨斯



沃尔沃



哈弗

CAR HEADLIGHT SERIES

汽车前灯系列



CAR HEADLIGHT SERIES

汽车前灯系列

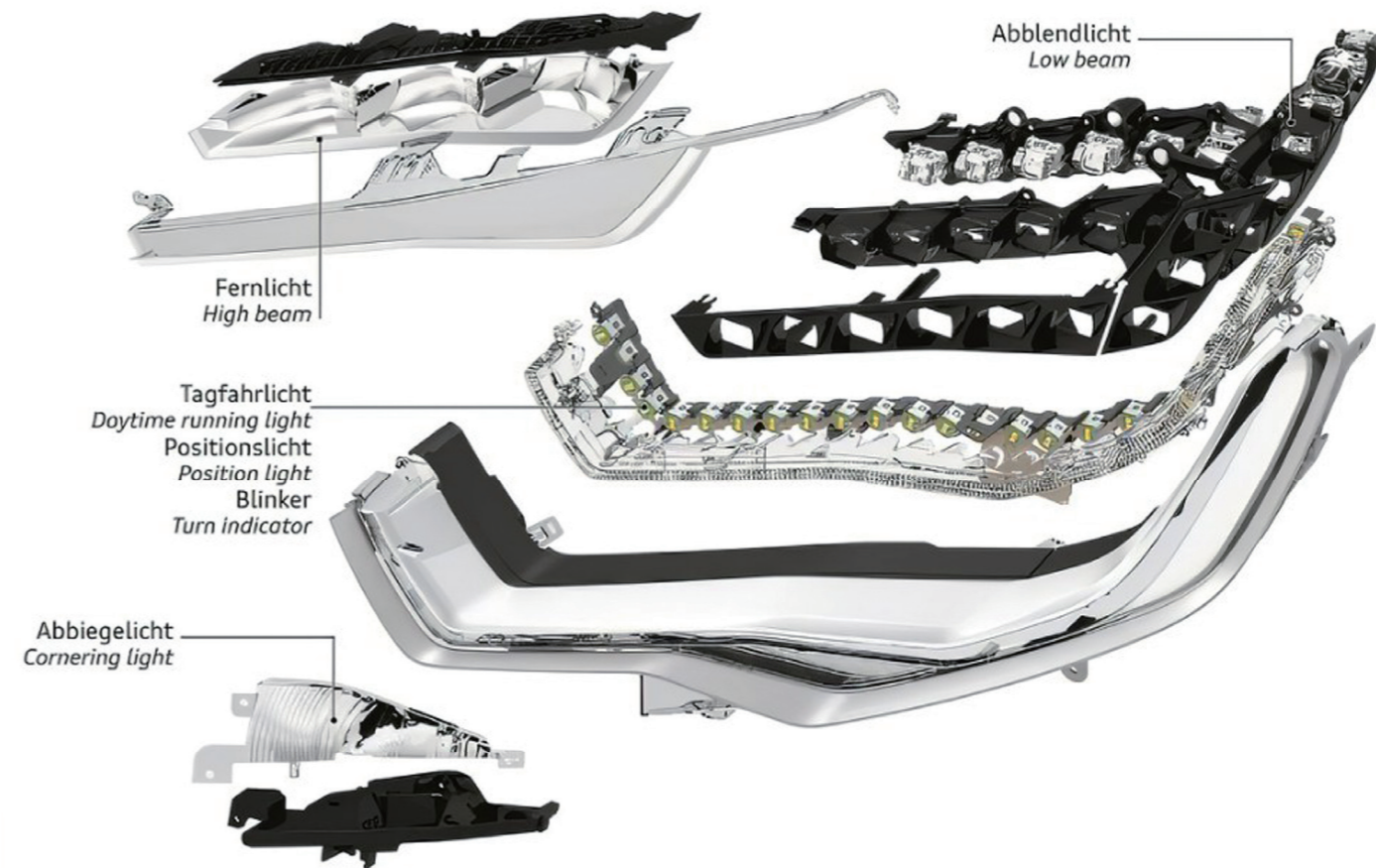

Internal Lampshade Series 内灯罩系列



- 前灯外透镜系列
- 前灯内透镜系列
- 前灯聚光器系列
- 前灯内灯罩系列
- 前灯导光条系列
- 前灯日间行车灯厚壁系列
- 前灯日间位置灯厚壁系列
- 前灯日间转向灯厚壁系列

- Headlight external lens series
- Headlight inner lens series
- Headlight condenser series
- Headlight inner lampshade series
- Headlight guide strip series
- Headlight day running light thick wall series
- Headlight day position light thick wall series
- Headlight day turn signal thick wall series

CAR TAILLIGHT SERIES

汽车尾灯系列



CAR TAILLIGHT SERIES

汽车尾灯系列



Car taillight Series 尾灯系列



- 尾灯转向灯厚壁系列
- 尾灯制动灯厚壁系列
- 尾灯倒车灯厚壁系列
- 尾灯雾灯厚壁系列
- 尾灯位置灯导光条系列
- 尾灯位置灯导光板系列
- 尾灯内灯罩系列
- 高位制动灯导光条系列
- 高位制动灯灯罩系列

- Taillight turn signal thick wall series
- Taillight brake light thick wall series
- Taillight backlight thick wall series
- Taillight fog light thick wall series
- Taillight position light guide strip series
- Taillight position light guide plate series
- taillight inner lamp shade series
- High brake light guide strip series
- High brake lamp shade series

CAR ATMOSPHERE LIGHT SERIES 汽车氛围灯系列



CAR ATMOSPHERE LIGHT SERIES

汽车氛围灯系列

- 氛围灯导光条系列
- 氛围灯导光板系列
- 氛围灯厚壁系列
- Atmosphere light guide strip series
- Atmosphere light guide plate series
- Atmosphere light thick wall series



HUD REFLECTORS FOR CARS SERIES

汽车 HUD 反射镜系列

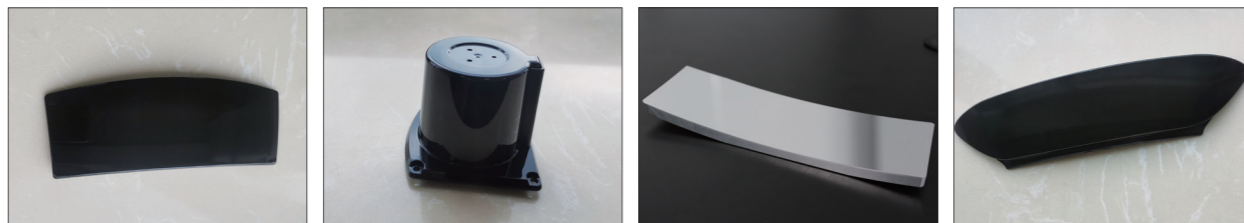
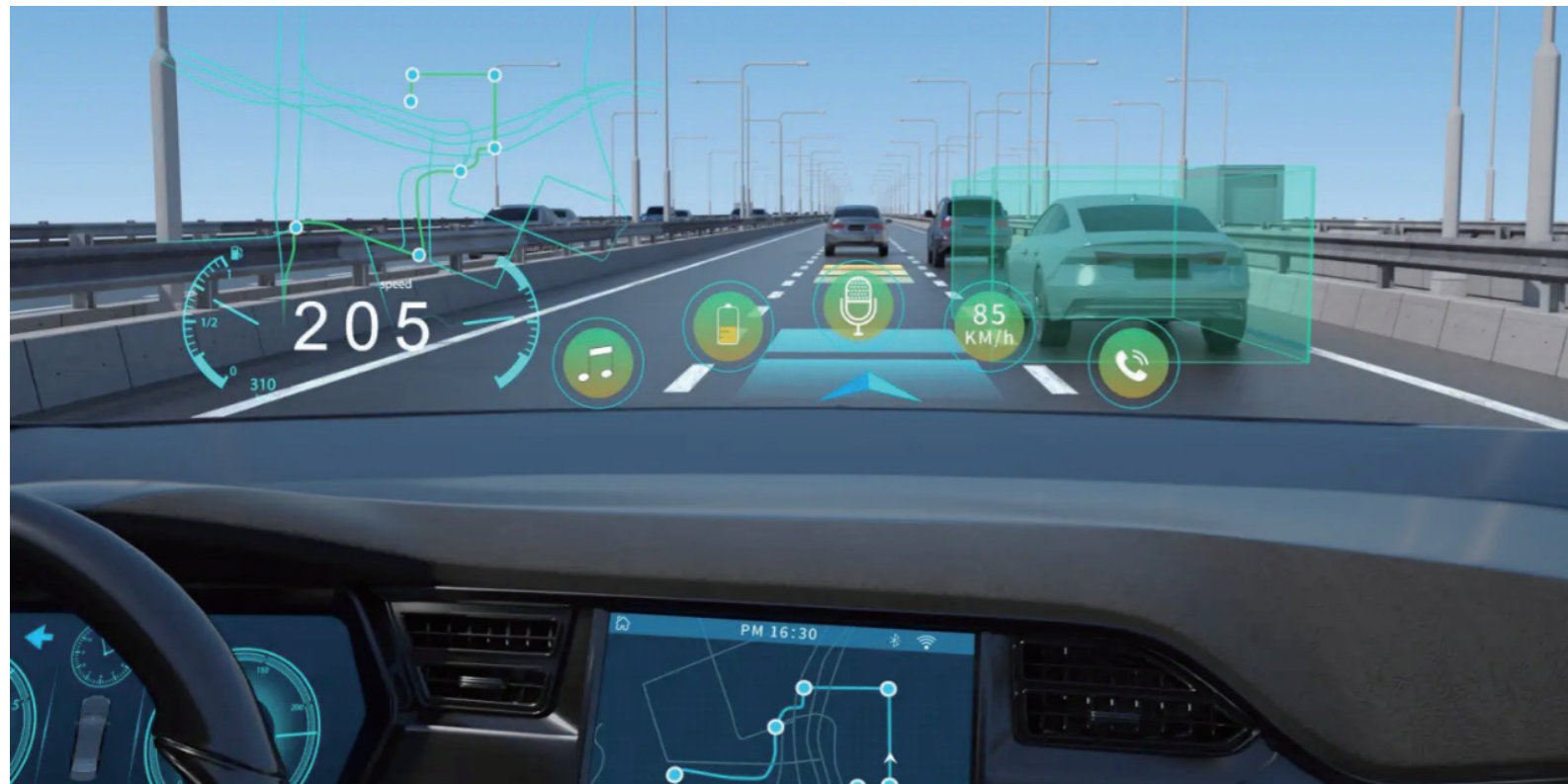

- HUD 凹面镜系列
- 雷达视窗系列
- 反射镜、光罩系列

- HUD concave mirror series
- Radar window series
- Mirror, light mask series

LASER RADAR WINDOW SERIES

激光雷达视窗系列

